

# HALE PET DOOR™

## INSTALLATION INSTRUCTIONS

### SCREEN MODEL – UNIVERSAL MODEL

Please read these instructions carefully and completely before attempting to install Hale Pet Doors; they will guide you through the steps and precautions needed for a screen installation. Illustrations and pictures have been added to help you understand various instructions. In order to reach an experienced installer for free consultation, please call 1-800-646-4773. Hale Pet Doors are designed for ease of installation which makes them ideal for any type of screen. Any person with a working knowledge of power or hand tools and basic home construction can install the Hale Pet Door™. It is important to note however, that the product warranty may be affected if returns have been modified in any way other than specified by these instructions. We cannot give credit for a door returned to us damaged.

**A SAFETY REMINDER!**  
Always wear eye protection and gloves when appropriate.

#### **Before installing:**

The Hale Pet Door Universal Screen Model is designed to fit into one of the lower corners of a screen door frame or screen window frame that over 1/2" thick. In screen frames that are 1/2" thick or less the standard screen model should be used although the universal model will work in those situations as well. The doors are very similar but the installation process differs between the two models. The universal screen pet door is completely reversible and will fit into either corner of the screen frame.

**Note:** The Hale Pet Door™ screen model is not designed to work on security doors. A “door” model is a much better choice for a security screen application.

**Step 1:** Before installation, be sure that you have the proper size pet door for the pet. If in doubt larger is better. It may be harmful for the pet to use a pet door that is too small. A good general rule is to install the pet door so that the distance from the floor to the top of the passage opening is above the shoulder of the largest pet. If the customer has more than one pet, make sure the tallest pet has shoulder clearance and the shortest pet will not have to jump through the opening.

**Step 2:** Take a brief look at the large diagrams of the screen model at the end of the instructions and become familiar with various components of the screen model. This will not only help in understanding the terms used in these instructions, but it can be very useful should you need to call for technical support.

**Step 3:** Check the package to make sure that it contains all the necessary parts.

Complete Kit includes:

Installation Booklet (includes warranty, policies, training, etc)

Hale Pet Door™ screen model      Screen spline 3/16"  
Phillips head screws 1/4"      7/64" drill bit

Metal screen retainer clips

Screen Stabilizer Bar Kit included with pet door sizes TL and larger (optional purchase with smaller pet doors)

Tools and supplies you may need:

Drill	Razor blade	Flat headed screwdriver or putty knife
Phillips headed screwdriver		Screen spline roller (handy but not necessary)
Needle-nosed pliers (optional)		Silicone caulk

**Step 4:** Determine which corner of the screen door is to be used for installing the pet door.





**Step 5:** Remove the screen window or door from its track. The screen door can generally be removed by lifting it upward and swinging the bottom outward. Occasionally the wheels will interfere with removal. In this case, the wheels will need to be lifted upward to clear the track.

**Step 6:** Lay the screen window or screen door on a flat surface with the screen spline facing upward.



**Step 7:** Remove the screen spline (the ribbed rubber around the screen) from the installation corner. Needle-nosed pliers work very well for removing the screen spline or you can also carefully use a flat head screwdriver or a putty knife at the corner to get started. If using a screwdriver or putty knife, be careful not to cut into the spline or slice into the finish of the door frame. **HINT:** Only remove the spline from the corner you will be working on, going a little bit farther than the finished size of the pet door. Leave the spline attached for the moment and just push or fold it out of the way.

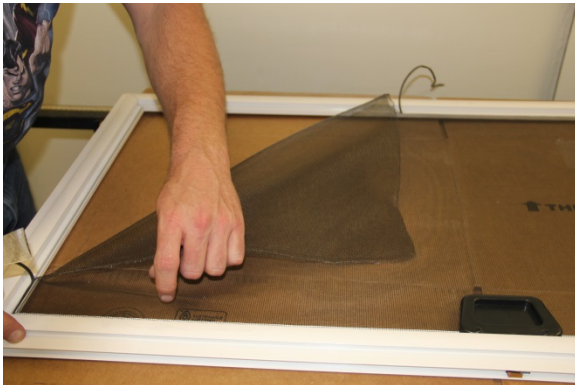
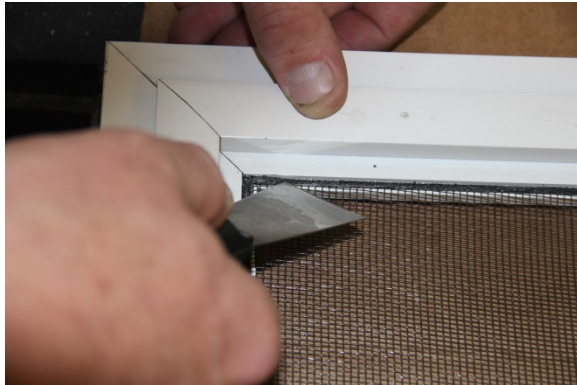



**Step 8:** Place the pet door snugly against the frame at the chosen corner. Make sure the pet door is adjusted properly and operates smoothly while in position. It should be flush against both the bottom and side edges.



**Step 9:** Place the metal screen retainer clips in the spline track of the people door evenly spaced around the pet door as shown. Depending on the size of the pet door ordered there should be between one and four clips in the bottom track and another one to four clips in the side track of the people door.



**Step 10:** Holding the pet door snugly against the people door frame, drill through the holes in the metal retainers into the frame of the pet door using the 7/64" drill bit provided.







**Step 11:** Insert the #6 screws with a Phillips screwdriver or drill as shown.

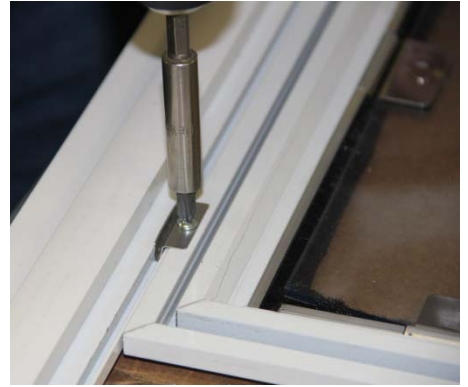

**Step 12:** Run a thin bead of silicone in the spline track on the people door along the side and bottom of the pet door running the silicone over the metal retainers as shown.



**Step 13:** Lay the screen material back over the pet door. Pull the screen material taut. To hold the screen fabric around the pet door, insert the screen spline that you previously pulled out of the people door with a flat headed screwdriver or screen spline roller.





**Step 14:** Clean any excess silicone off the people door and the pet door with a paper towel, if needed.



**Step 15:** Using a razor blade, carefully cut the screen fabric inside the perimeter of the pet door near the weather stripping. Be sure to leave enough screen fabric to be pulled down into the track by the screen spline that came with your pet door. You can trim off any excess fabric after the installation is complete. Remove the square of screen fabric and discard.

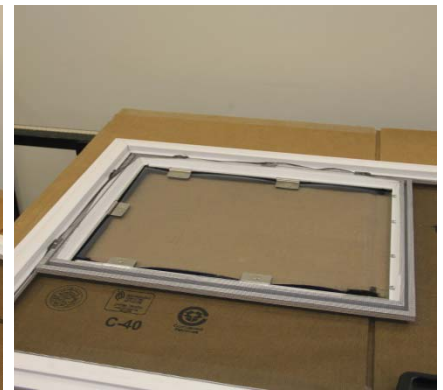

**Step 16:** Insert the screen spline included with your pet door into the spline frame track around all four sides of the pet door being sure to pull the screen fabric taut to make the pet door more secure.





This means that on the bottom and one side of your pet door you will have two pieces of screen spline: One in the people door track (black spline at top of picture below) and one in the pet door track (light gray spline at bottom of picture below) with a narrow strip of screen fabric between them.



NOTE: When installing the spline in the corner of the pet door unit, it may be necessary to cut a small diagonal slit up into the screen material in order to relieve the tension on the screen fabric and allow it to be pulled down into the spline frame track. NOTE: Be careful not to cut too far into your screen fabric or you will have a hole at the corner of your pet door.

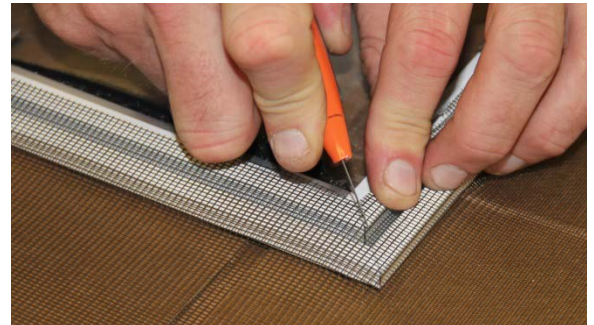

**Step 17:** Cut away any excess screen spline with a razor blade or scissors. Cut away the excess screen material with a razor blade being careful not to cut into the screen spline or the finish of the pet door. If you are installing a stabilizer bar (see next section), leave some excess screen material at this time. You can trim it later after installing the stabilizer bar kit.



**Step 18:** Re-install the screen door or screen window.



**Step 19:** After re-installing the screen into a vertical position, adjust the magnets in the pet door upward or downward if needed. The magnets are pressure fitted and can be adjusted downward by tapping lightly with the handle of your screwdriver. They can be adjusted upward by twisting a flat headed screwdriver below the magnet between the magnet and frame. **Be sure to adjust the magnets**

**upward from the inside of the door so as not to mar the outer door finish.**



## Installed Hale Universal Screen Model Pet Doors



Above two photos show the pet door installed with the stabilizer bar kit.

### TECHNICAL SPECIFICATIONS:

**Flaps:** Single flap made of flexible 3/16" clear PVC vinyl.

**Spline Frame:** Extruded 6063-T5 aluminum with .063" wall thickness.

**Alnico5 Magnets:** A 1/4" rod magnet 1 1/2" long made from an aluminum, nickel and cobalt alloy known for its strength and durability. Door size determines number of magnets.

**Strikes:** Made of ferrous stainless steel. 1 1/2" long, 3/4" tall and 1/32" thick. U-shaped with interior prongs, when pressed onto the vinyl flap, the barbed prongs hold firmly.

**Weather-stripping:** Flap is surrounded by 1/2" nylon pile for maximum insulation. Nylon is woven into a backing 9/32" wide and 1/32" thick.

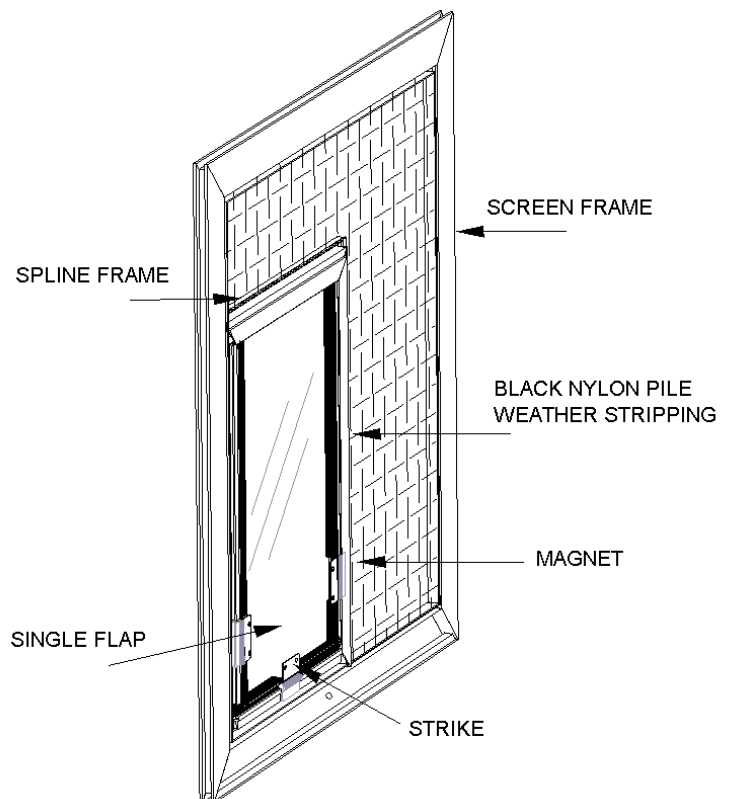

## Optional Stabilizer Bar Kit for Screen Model Installation Information and Installation Instructions

For our screen model pet doors, size Large and above, or if you have more than one pet, we recommend adding the optional Stabilizer Bar Kit for additional stability for your pet door and people door alike. The Stabilizer Bar Kit contains a spreader bar, 2 aluminum clips to attach the bar to the frame of your screen door, 2 metal screen retainers to attach the bar to the top edge of the pet door and a drill bit to drill the holes into the spreader bar for the retainers.

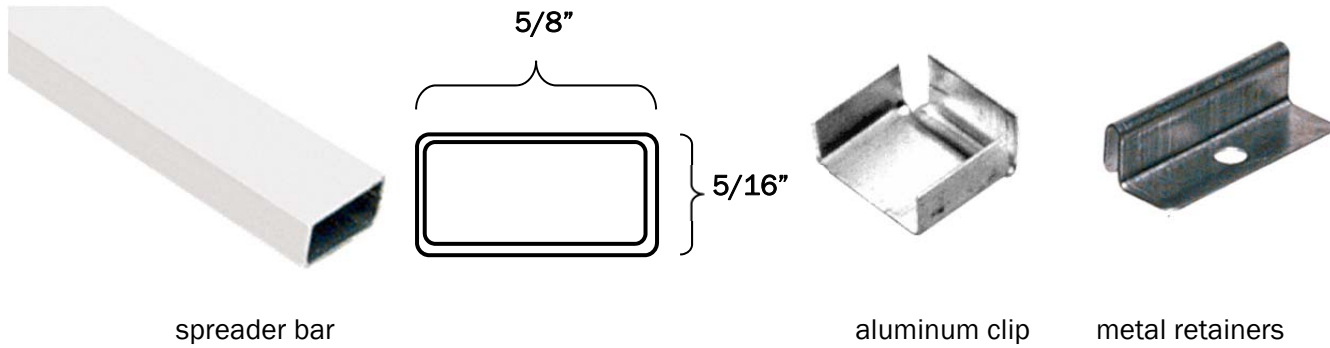

The spreader bar is designed to be installed as a brace across the screen door directly above the pet door to add rigidity and strength both to the screen door itself and to the unsupported edge of the pet door. This can be especially important for very large or very active dogs.

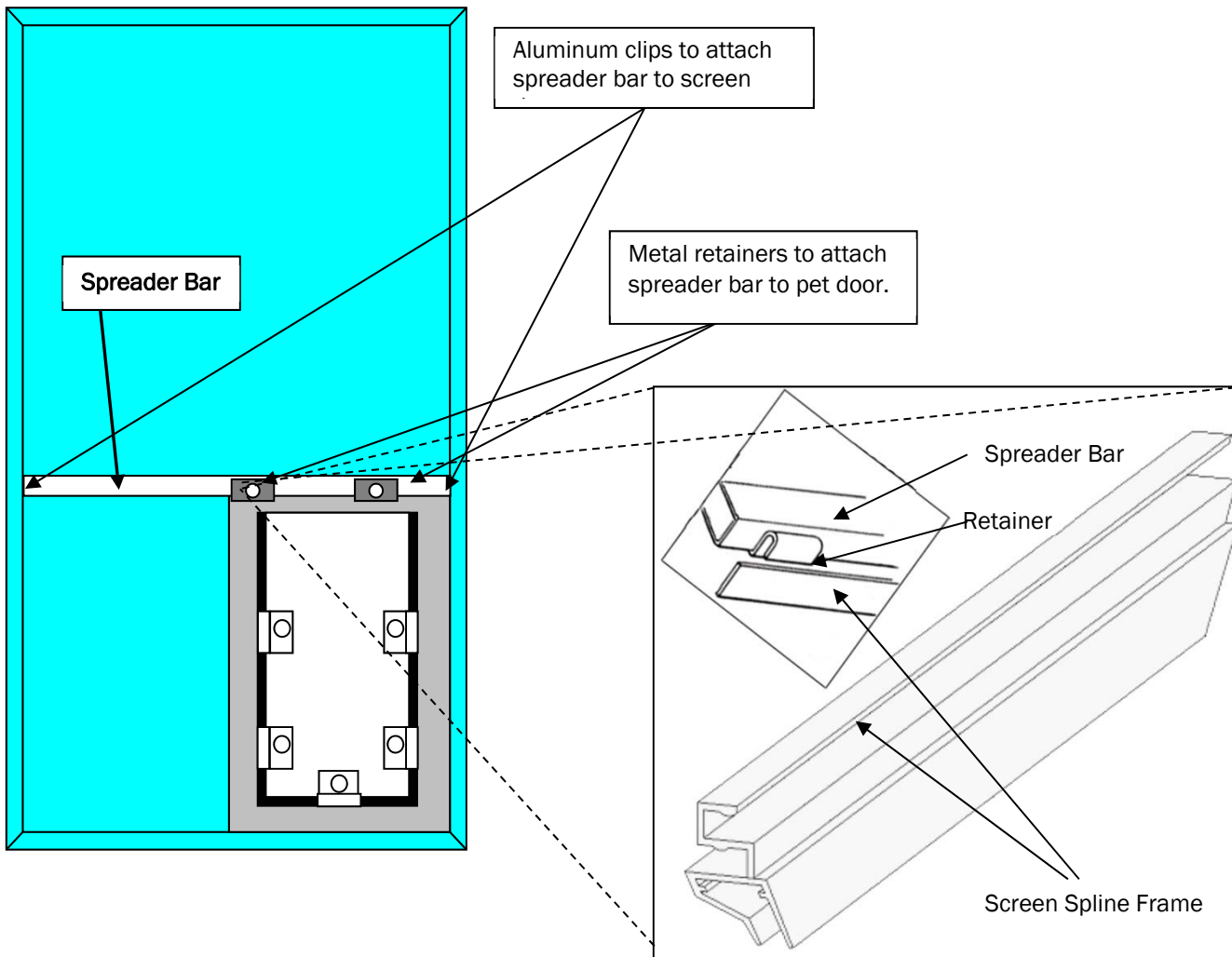



**Step 1:** Install the screen door as normal. The stabilizer bar kit can either be installed at the same time as the pet door or can be retrofitted to an existing pet door. If it is being installed at the time of the screen door installation, we recommend leaving some excess screen mesh material during installation. It can be trimmed after the stabilizer bar installation is complete.



**Step 2:** Measure the width of the screen door from the side containing the screen spline. This measurement should be the visible opening between the screen frames.

**Step 3:** Using this measurement, measure and mark this distance on the stabilizer bar.



**Step 4:** Cut the stabilizer bar to the proper length. It is easiest to accomplish this with a hacksaw. After you cut the bar to length, make sure you de-burr your cut to allow the aluminum clip to fit in properly. Test fit the bar to the screen door frame to check for proper width. Re-cut the bar shorter if needed.

**Step 5:** On the side of the screen door containing the pet door, with a screwdriver, carefully pull a short amount of screen spline out of the screen spline frame or raceway directly above the pet door. Repeat the process on the other side of the screen

door frame at approximately the same height above the pet door. Take care not to scratch the finish of the screen door or poke a hole in the screen mesh fabric when removing the screen spline. Also do not pull out too long a distance of screen spline as it will be more difficult to push back in place later.



**Step 6:** Making sure that both clips face the correct direction to fit over the screen door raceway, carefully slide one aluminum clip into each end of the spreader bar. Take care not to push them too far into the spreader bar or there may not be enough clearance for the raceway.

**Step 7:** The spreader bar is generally installed on the side of the screen mesh opposite the spline. On the same side of the screen fabric as the pet door, carefully insert the spreader bar into the frame opening of the screen door, sliding the curved portion of the aluminum clips over and onto the edge of the raceway on the screen door.



Depending on what type of screen door you are installing in (i.e. a sliding screen door on a patio door), you may have to work at getting one end of the spreader bar positioned correctly. Take care not to push the end of the spreader bar through the screen material if there is a slight obstruction where you are working.

**NOTE:** Depending on the exact construction of your screen door and the placement of your screen fabric and screen spline in relation to the pet door, the next instructions may be done in reverse order. If it is easier to complete the installation and then put the screen spline back in place, feel free to do so.

**Step 8:** Making sure the screen mesh is taut, carefully push the screen spline back into place. The easiest method for this is to use a screen spline roller. However, you can use a screwdriver or other flat tool to accomplish this if you do not have a screen spline roller. The pressure from the screen spline against the edges of the screen raceway will hold the aluminum clip firmly in place against the screen frame on both edges.

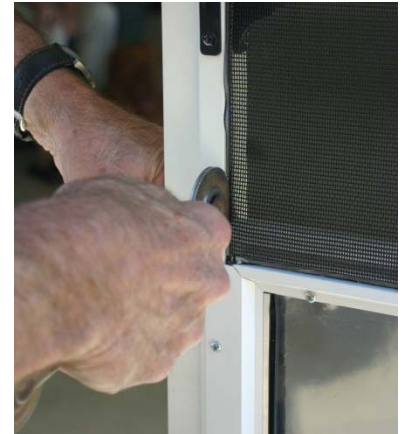

**Step 9:** Slide one metal retainer over the top edge of the pet door screen spline frame. This retainer should be close to the outer corner of the pet door. Slide the second metal retainer onto the pet door frame approximately halfway between the exterior corner and the edge of the pet door attached to the screen door. (This second retainer will provide added stability but its positioning is not critical. Anywhere along the top edge of the pet door is acceptable.) If desired, you can attach the retainers on the top edge near each corner. The exact placement depends on your screen door and the size of pet door you are installing. When you are happy with the placement of the retainers, carefully push the spreader bar down

flush against the top of the pet door. The edge of the retainer clip with the hole should be alongside the edge of the spreader bar parallel to the pet door.

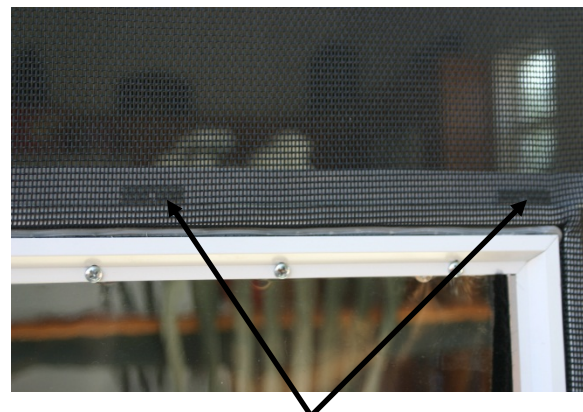

Interior and Exterior view of metal retainer clips attached to pet door and resting against spreader bar.



**Step 10:** Depending on the layout of your screen door, the retainer clips may be between the screen mesh and the spreader bar or on the side opposite the fabric. No matter where the holes are located, the clips need to be attached to the spreader bar with screws. If the screen mesh is not an issue, simply screw through each clip into the spreader bar. If the clips are underneath the screen mesh, you have two options.

- ❖ Option 1: If you did not press the screen spline back into place (step 8 above) you should be able to carefully pull the screen fabric upwards and out of the way to install the screws. Then pull the screen mesh back down to cover the area and install spline.
- ❖ Option 2: You can screw directly through the screen mesh fabric to attach the clips. (This is the option shown in the below pictures.)



For either option, once the screw has started, reach through the pet door and press the spreader bar firmly against the retainer clip to ensure a good connection between the two.



**Step 11:** Check the overall installation making sure everything is straight and level and the screen mesh is taut. Double check that the screen spline is pushed securely back into place on both sides of the screen door as well as along the top edge of the pet door. If this is a new installation and you did not previously trim the screen mesh fabric close to the pet door, do so at this time. Remove drop cloths and do any necessary cleanup, including cleaning the pet door frame and flaps if needed.

The installation is now complete.

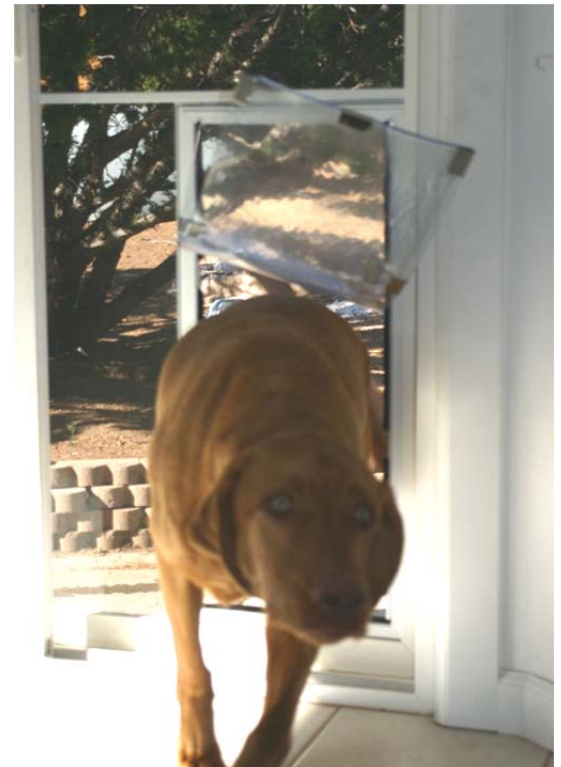

Installed Hale Pet Door Screen Model with Optional Stabilizer Bar Kit

Above Left to Right:  
Interior View, Exterior View

Right: Close-Up View

The stabilizer bar kit is a great addition to a screen model pet door used by large or active dogs or by multi-dog families.

